

NOTES:

1. GAS/DIESEL USE
2. ENVIROLASTIC 940 DTM POLYASPARTIC URETHANE COATING FOR HIGH PERFORMANCE FINISH (MEMCO GREY)
3. UL 2085 LABELED AND LISTED
4. 2 HOUR RATING TESTED TO SWRI 97-04 NFPA 30 A FIRE RESISTANT TANK
5. ENGINEERED HURRICANE TIE-DOWN
6. LEAD TIME IS DEPENDENT ON IMMEDIATE APPROVAL

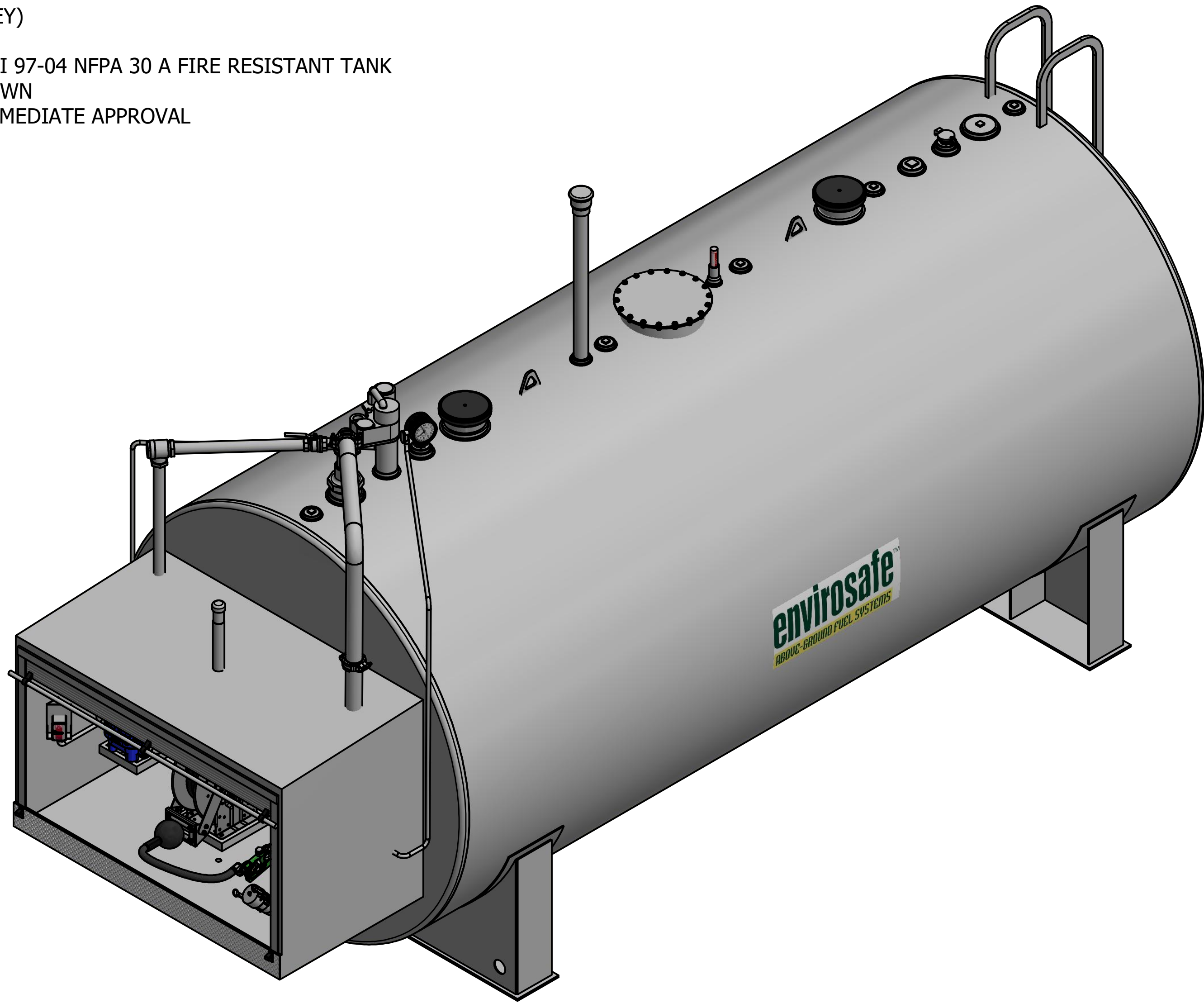

LEAD TIMES BEGIN UPON RECEIPT OF SIGNED APPROVED DRAWING, WHICH MUST BE RETURNED BEFORE PRODUCTION CAN BEGIN

#

STI
SwRI
UL

This document and all information and design thereon are the property of Envirosafe Fuel Systems. This document is confidential and must not be made public or copied without written authorization from Envirosafe and is subject to return upon demand. No use of this document or any design thereon is permitted except as is specifically authorized in writing by Envirosafe. Acceptance of possession of this document constitutes full agreement with the above conditions. All Rights Reserved. Memco, Inc

DRAWN BY Akshar Patel MEMCO REP	4/24/2019	MEMCO, INC	
QUOTE #		 6000 GALLON FIREGUARD COMMERCIAL FLEET	
Customer Approval Signature			
CUSTOMER REQUESTED COMPLETION DATE :		SIZE C	DWG NO
		SCALE	REV
		SHEET 1 OF 5	

PARTS LIST		
ITEM	QTY	DESCRIPTION
1	1	6,000 GALLON FIREGUARD TANK MOUNTED ON SADDLES
2	1	18" MANWAY FOR EASY INNER TANK ACCESSIBILITY
3	2	8 IN NPT THREADED FLANGE
4	2	6 IN NPT THREADED FLANGE
5	4	4 IN NPT THREADED FLANGE
6	5	3" NPT THREADED FLANGE (CONCRETE PORT)
7	1	3 IN NPT THREADED FLANGE
8	2	2 IN NPT THREADED FLANGE
9	2	LIFTING LUG
10	2	VENT EMERGENCY 8IN 8OZ./SQ.IN- MALE THREAD- w/O-RING
11	1	UL LISTED LOCKABLE FILL BOX 3'6" X 6'6" X 4'2" CROSS BROKEN FOR EASY DRAINAGE, 2" VENT, MUSHROOM CAP, 1/2" BALL VLAVE
12	1	3" OVERFILL PREVENTION VALVE WITH TEST MECHANISM AND DIFFUSER
13	1	3" GROUND LEVEL FILL WITH DUST CAP AND ADAPTOR
14	1	FE PETRO 3/4 HP w/RISER, 88IN - 149IN (240V 1 PH)
15	1	918 CLOCK GAUGE WITH ALARM BOX AND STANDARD FLOAT
16	1	TOTAL CONTROL 682-15 PISTON METER WITH 10:1 PULSER

PARTS LIST		
ITEM	QTY	DESCRIPTION
17	1	CIM-TEK 1 1/2" FILTER ADAPTER, 1" SPIN-ON FILTER
18	1	VALVE BALL 1-1/2IN
19	1	VALVE BALL 2IN
20	1	2" ANTI-SYPHON VALVE
21	1	REEL HOSE N800 1" SPRING INLET RIGHT W/1"x25' HOSE, 1"x12' HOSE WHIP, 1" NOZZLE, 1" SWIVEL, 1" BREAKAWAY, 1" HOSE BUMPER
22	1	PUMP SWITCH, COVER & BACKPLATE, 1/2" EXPLOSION PROOF BOX
23	1	STEP LADDER WITH SAFETY SHIELD
24	1	INTERSTITIAL LEAK GAUGE
25	1	3" UPDRAFT STACK W/3" 354 SLIP ON
26	1	MONITORING CAP 2"
27	1	TANK DECAL KIT (NOT SHOWN)
28	1	TOUCH UP PAINT (NOT SHOWN & SHIPPED SEPARATELY)
29	6	1" REPLACEMENT FILTER (NOT SHOWN & SHIPPED SEPARATELY)

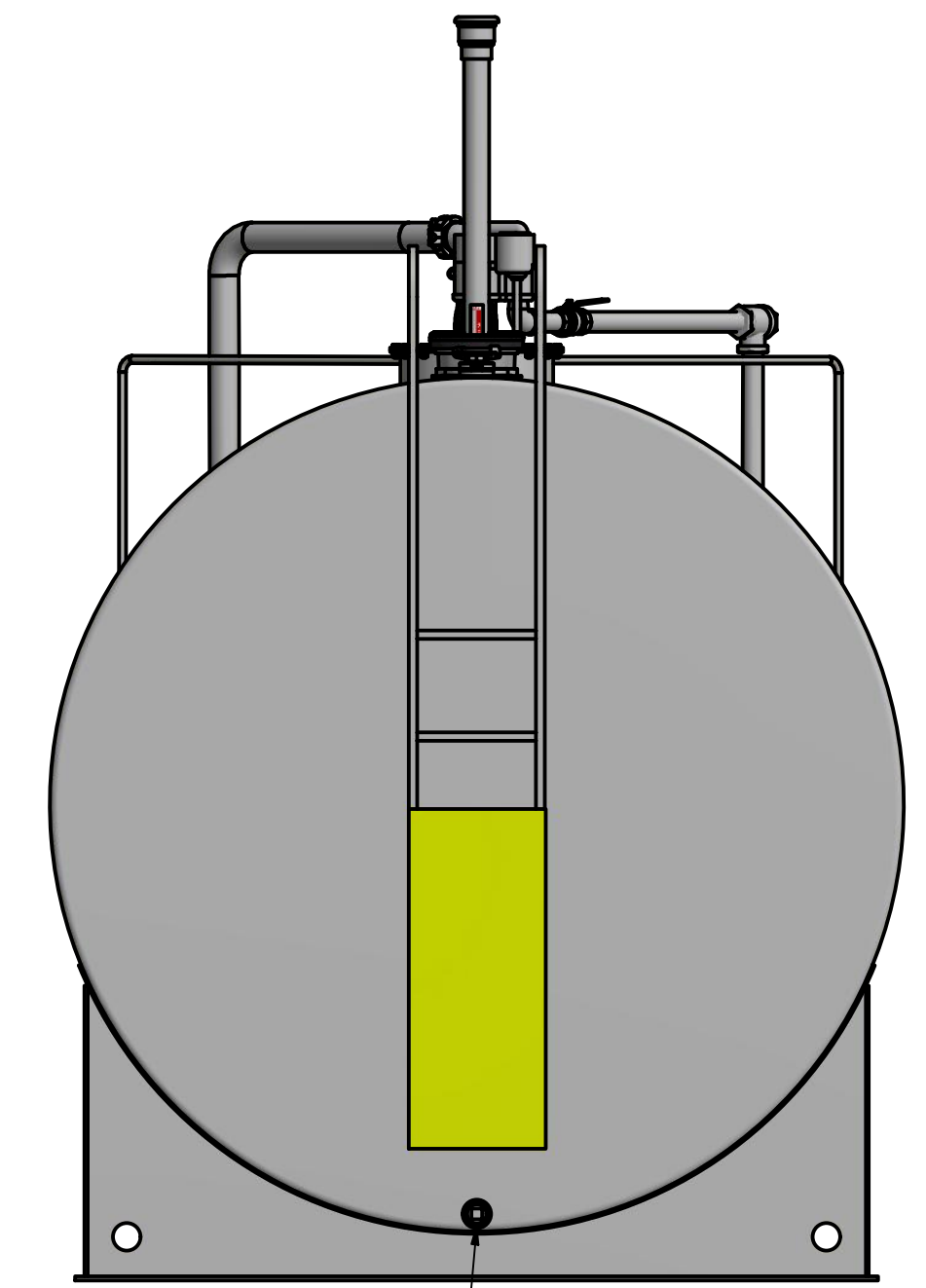
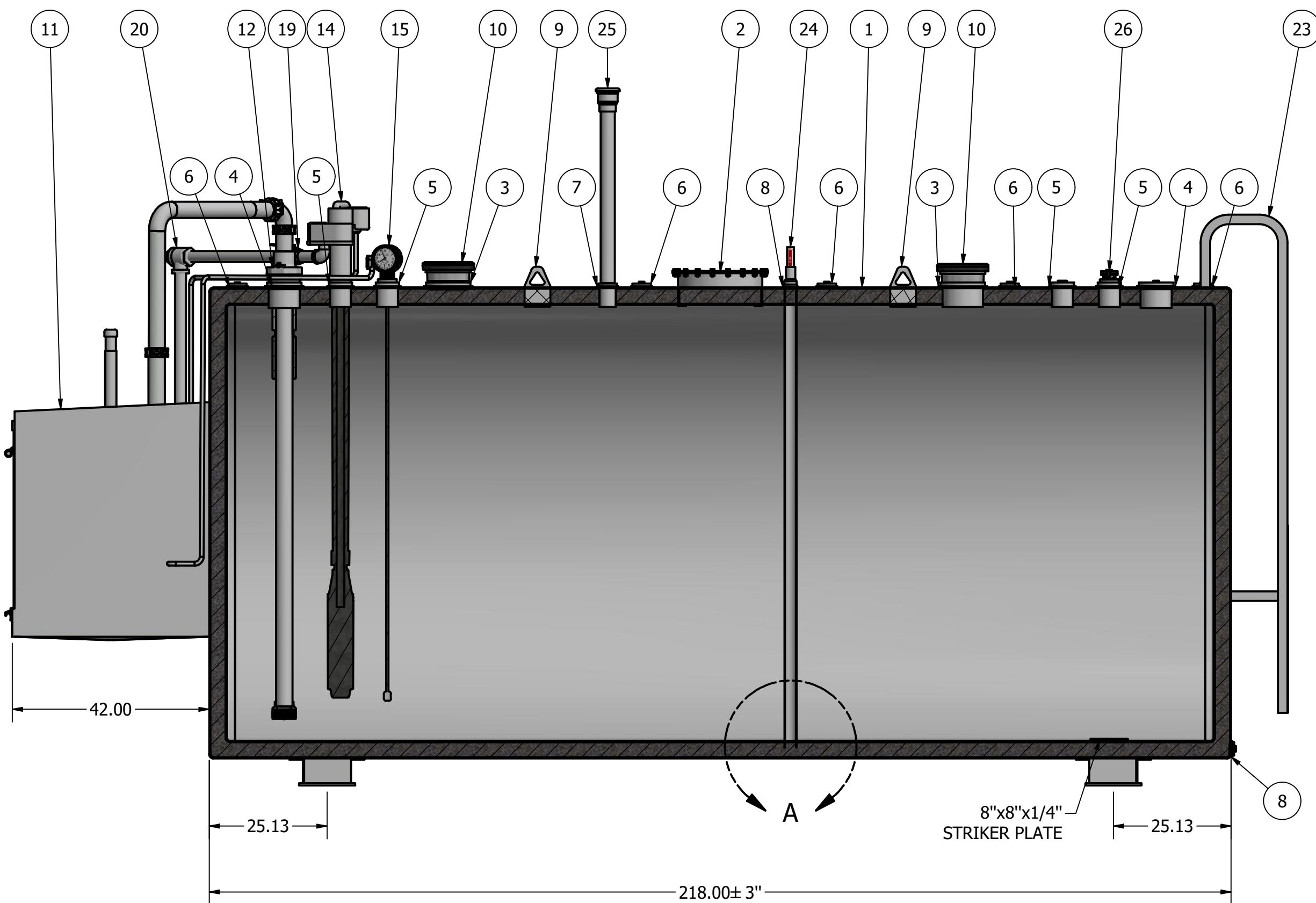
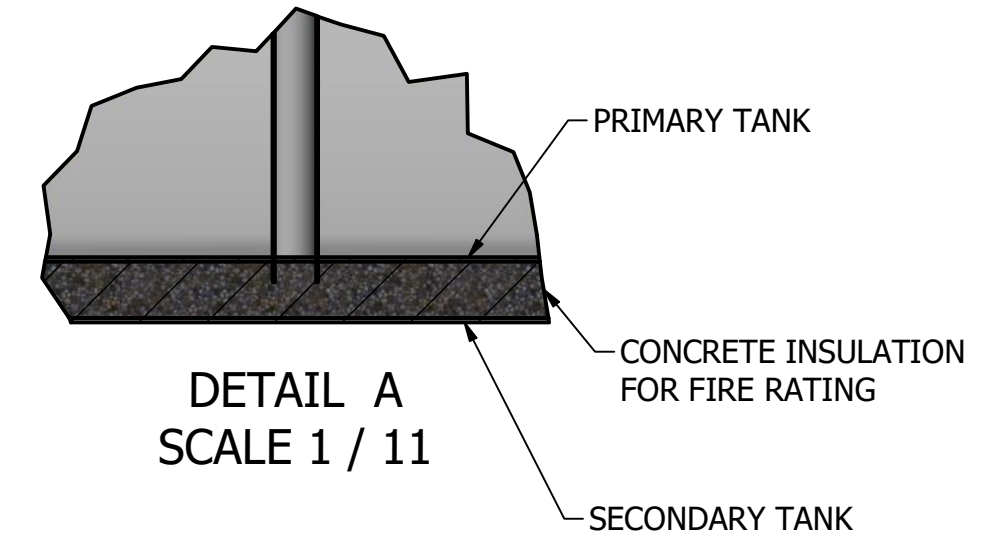

LEAD TIMES BEGIN UPON RECEIPT OF SIGNED APPROVED DRAWING, WHICH MUST BE RETURNED BEFORE PRODUCTION CAN BEGIN

#

SHELL THICKNESS: 1/4"
HEAD THICKNESS: 5/16"

STI
SwRI
UL

This document and all information and design thereon are the property of Envirosafe Fuel Systems. This document is confidential and must not be made public or copied without written authorization from Envirosafe and is subject to return upon demand. No use of this document or any design thereon is permitted except as is specifically authorized in writing by Envirosafe. Acceptance of possession of this document constitutes full agreement with the above conditions. All Rights Reserved. Memco, Inc

DRAWN BY Akshar Patel MEMCO REP	4/24/2019
QUOTE #	
Customer Approval Signature	

MEMCO, INC

envirosafe[™]
ABOVE-GROUND FUEL SYSTEMS

6000 GALLON FIREGUARD COMMERCIAL FLEET

SIZE C	DWG NO	REV
SCALE	SHEET 2 OF 5	

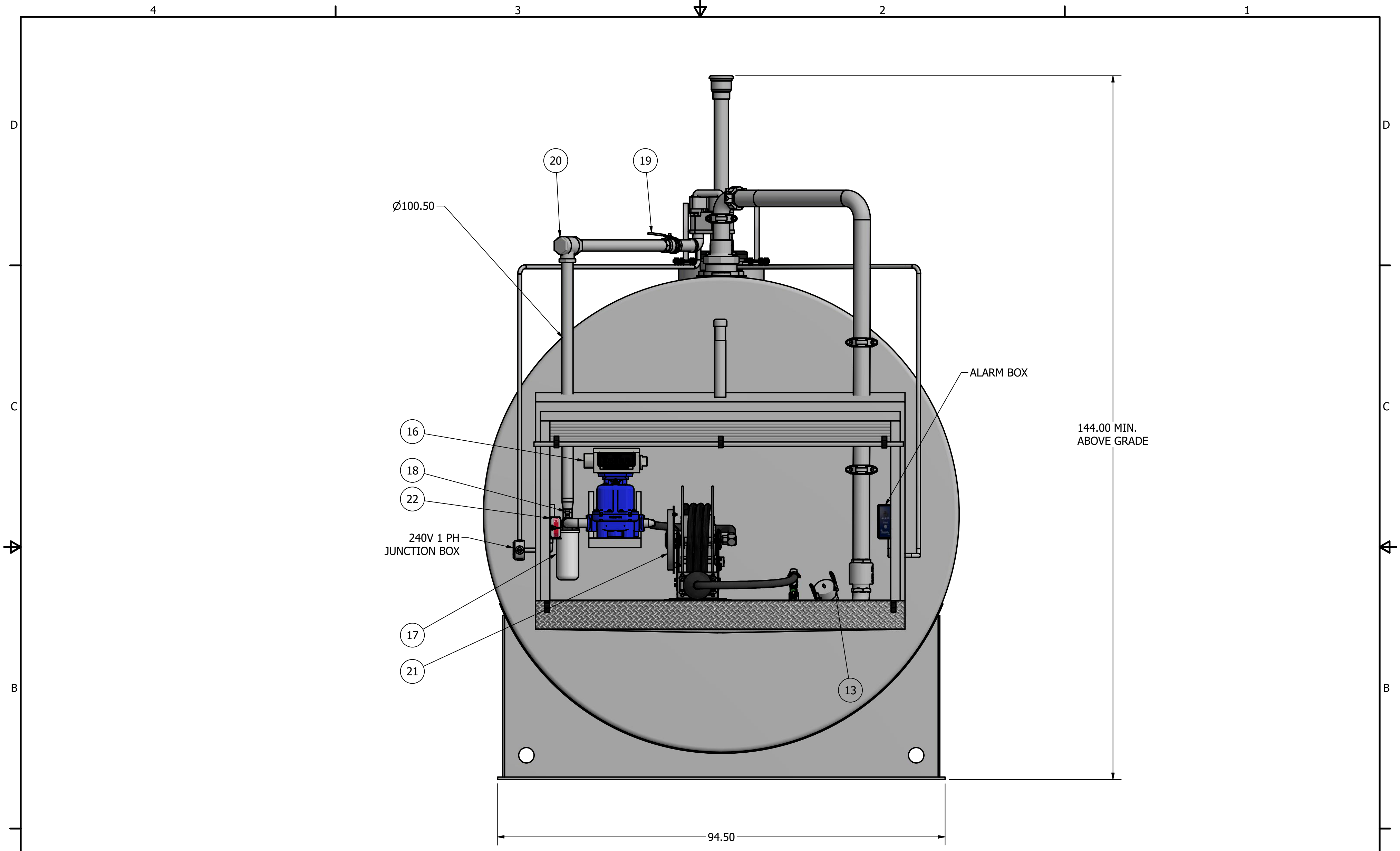

LEAD TIMES BEGIN UPON RECEIPT OF SIGNED APPROVED DRAWING, WHICH MUST BE RETURNED BEFORE PRODUCTION CAN BEGIN #

STI
SwRI
UL

This document and all information and design thereon are the property of Envirosafe Fuel Systems. This document is confidential and must not be made public or copied without written authorization from Envirosafe and is subject to return upon demand. No use of this document or any design thereon is permitted except as is specifically authorized in writing by Envirosafe. Acceptance of possession of this document constitutes full agreement with the above conditions. All Rights Reserved. Memco, Inc

DRAWN BY Akshar Patel MEMCO REP		4/24/2019		MEMCO, INC	
QUOTE #				 6000 GALLON FIREGUARD COMMERCIAL FLEET <small>ABOVE-GROUND FUEL SYSTEMS</small>	
Customer Approval Signature					
SIZE C	DWG NO			REV	
SCALE				SHEET 3 OF 5	