

NOTES:

1. GAS/DIESEL USE
2. ENVIROLASTIC 940 DTM POLYASPARTIC URETHANE COATING FOR HIGH PERFORMANCE FINISH (MEMCO GREY)
3. UL 2085 LABELED AND LISTED
4. 2 HOUR RATING TESTED TO SWRI 97-04 NFPA 30 A FIRE RESISTANT TANK
5. ENGINEERED HURRICANE TIE-DOWN
6. LEAD TIME IS DEPENDENT ON IMMEDIATE APPROVAL

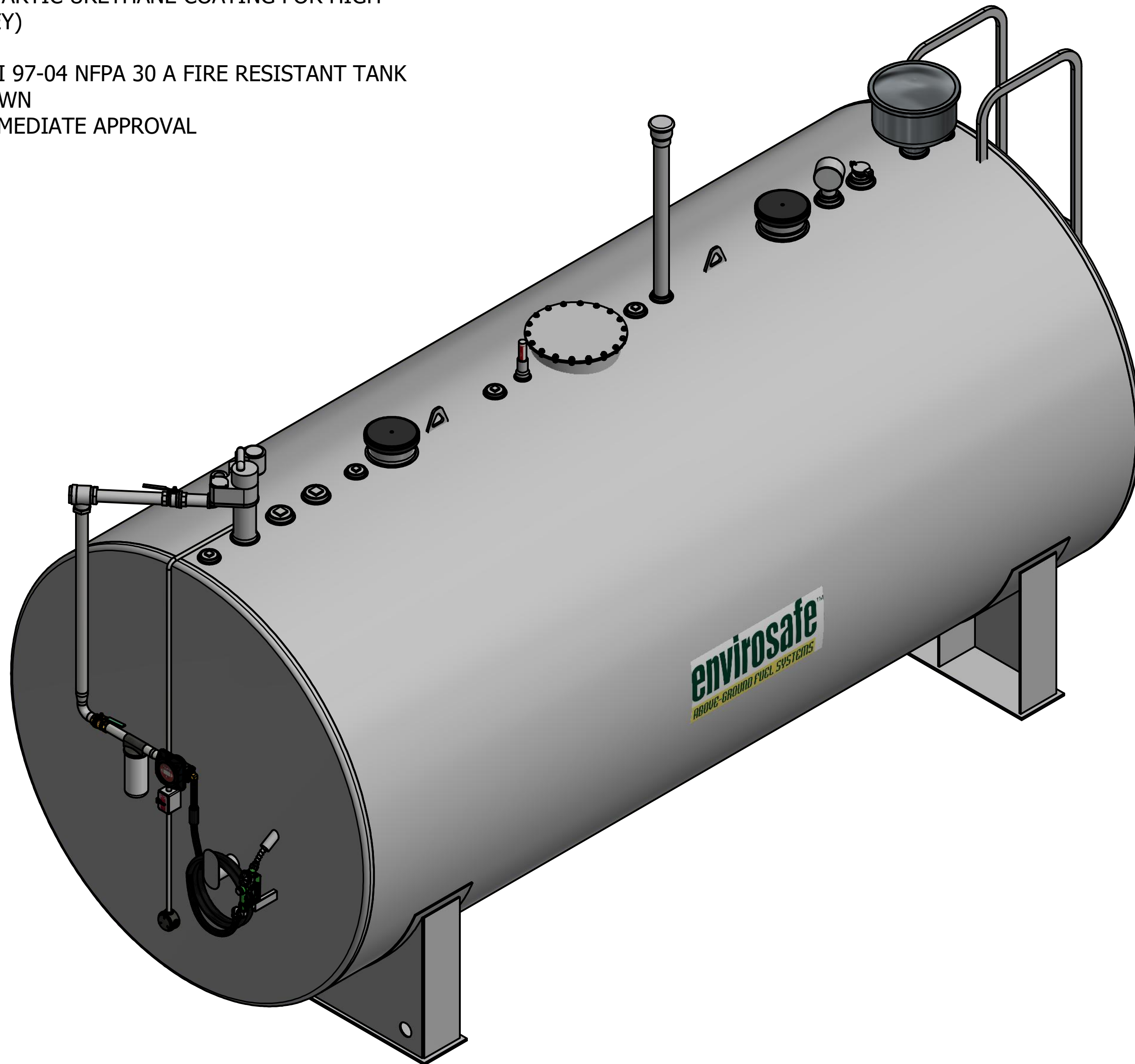

LEAD TIMES BEGIN UPON RECEIPT OF SIGNED APPROVED DRAWING, WHICH MUST BE RETURNED BEFORE PRODUCTION CAN BEGIN

#

STI
SwRI
UL

This document and all information and design thereon are the property of Envirosafe Fuel Systems. This document is confidential and must not be made public or copied without written authorization from Envirosafe and is subject to return upon demand. No use of this document or any design thereon is permitted except as is specifically authorized in writing by Envirosafe. Acceptance of possession of this document constitutes full agreement with the above conditions. All Rights Reserved. Memco, Inc

DRAWN BY AP		9/20/2019		MEMCO, INC	
MEMCO REP				 6,000 GALLON FIREGUARD FARM FLEET SYSTEM	
QUOTE #6000 GALLON FG FARM FLEET					
Customer Approval Signature				SIZE C	DWG NO 6000 GALLON FG FARM FLEET
CUSTOMER REQUESTED COMPLETION DATE :				SCALE	REV
				SHEET 1 OF 4	

PARTS LIST		
ITEM	QTY	DESCRIPTION
1	1	6,000 GALLON FIREGUARD TANK MOUNTED ON SADDLES
2	1	18" MANWAY FOR EASY INNER TANK ACCESSIBILITY
3	2	8 IN NPT THREADED FLANGE
4	6	4 IN NPT THREADED FLANGE
5	5	3" NPT THREADED FLANGE (CONCRETE PORT)
6	1	3 IN NPT THREADED FLANGE
7	2	2 IN NPT THREADED FLANGE
8	2	LIFTING LUG
9	2	VENT EMERGENCY 8IN 8OZ./SQ.IN- MALE THREAD- w/O-RING
10	1	INTERSTITIAL LEAK GAUGE
11	1	3" UPDRAFT STACK W/3" 354 SLIP ON
12	1	MONITORING CAP 2"
13	1	2IN NPT SQUARE PLUG
14	1	FE PETRO 3/4 HP w/RISER, 88IN - 149IN (240V 1 PH)
15	1	VALVE BALL 2IN

PARTS LIST		
ITEM	QTY	DESCRIPTION
16	1	2" ANTI-SIPHON VALVE
17	1	818-CLOCK-GAUGE WITH STANDARD FLOAT
18	1	7.5 GALLON OVERSPILL CONTAINER WITH LOCKABLE LID
19	1	2" OVERFILL PREVENTION VALVE W/3" MALE QUICK DISCONNECT X 4" FEMALE THREADS, DIFFUSER, TEST MECHANISM AND DUST CAP
20	1	STEP LADDER WITH PLATFORM AND SAFETY SHIELD
21	1	METER 6-40 GPM DIGITAL. 1" NPT INLET/OUTLET. ACCURACY OF +/- 1.25%
22	1	CIM-TEK 1 1/2" FILTER ADAPTER, 1" SPIN-ON FILTER
23	1	VALVE BALL 1-1/2IN
24	1	PUMP SWITCH, COVER & BACKPLATE, 1/2" EXPLOSION PROOF BOX FEED THRU
25	1	1 IN HUSKY DIESEL NOZZLE WITH 1" SWIVEL AND 1" BREAKAWAY
26	1	TANK DECAL KIT (NOT SHOWN)
27	6	1" REPLACEMENT FILTERS (NOT SHOWN AND SHIPPED SEPARATELY)
28	1	TOUCH UP PAINT (NOT SHOWN AND SHIPPED SEPARATELY)

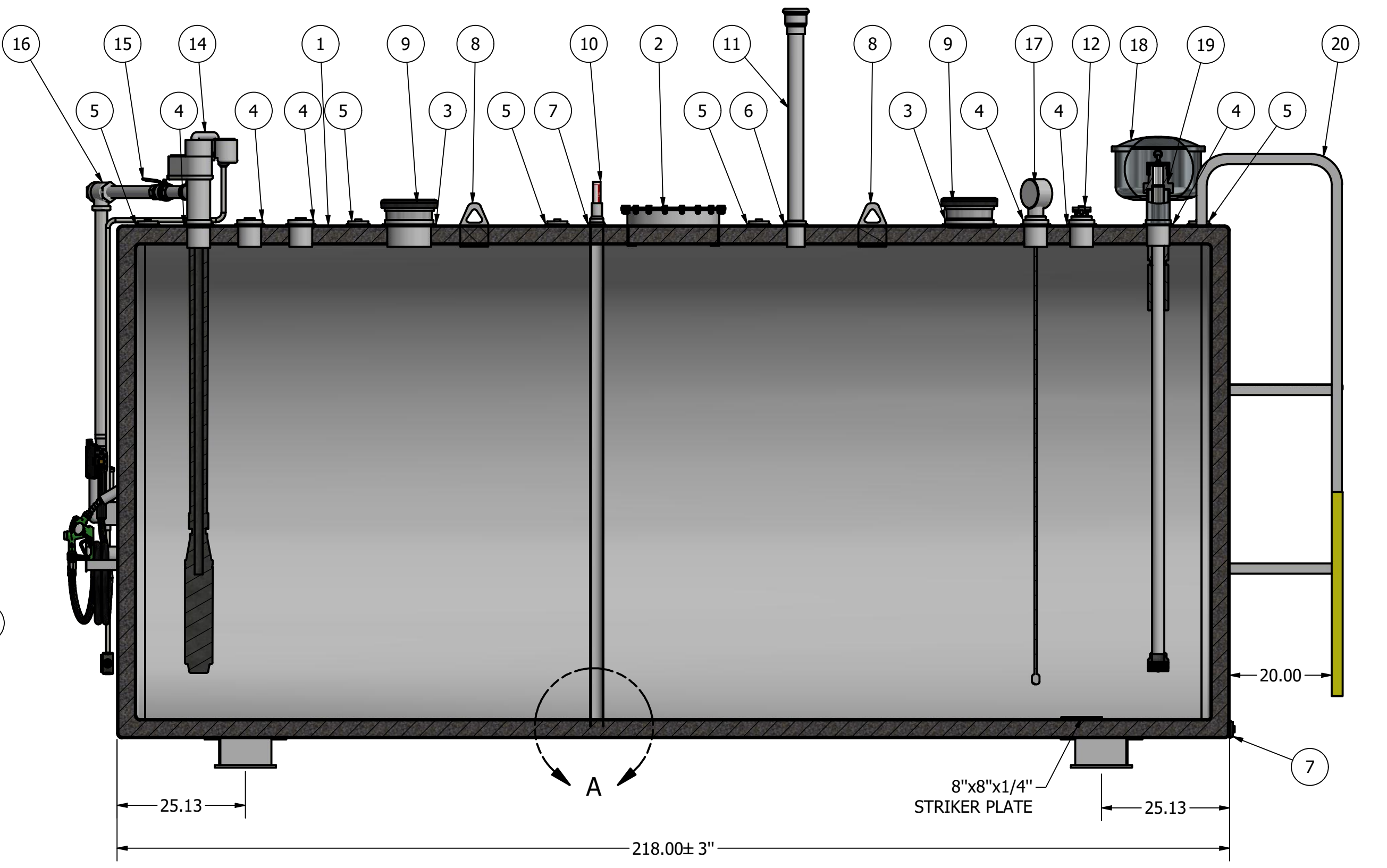
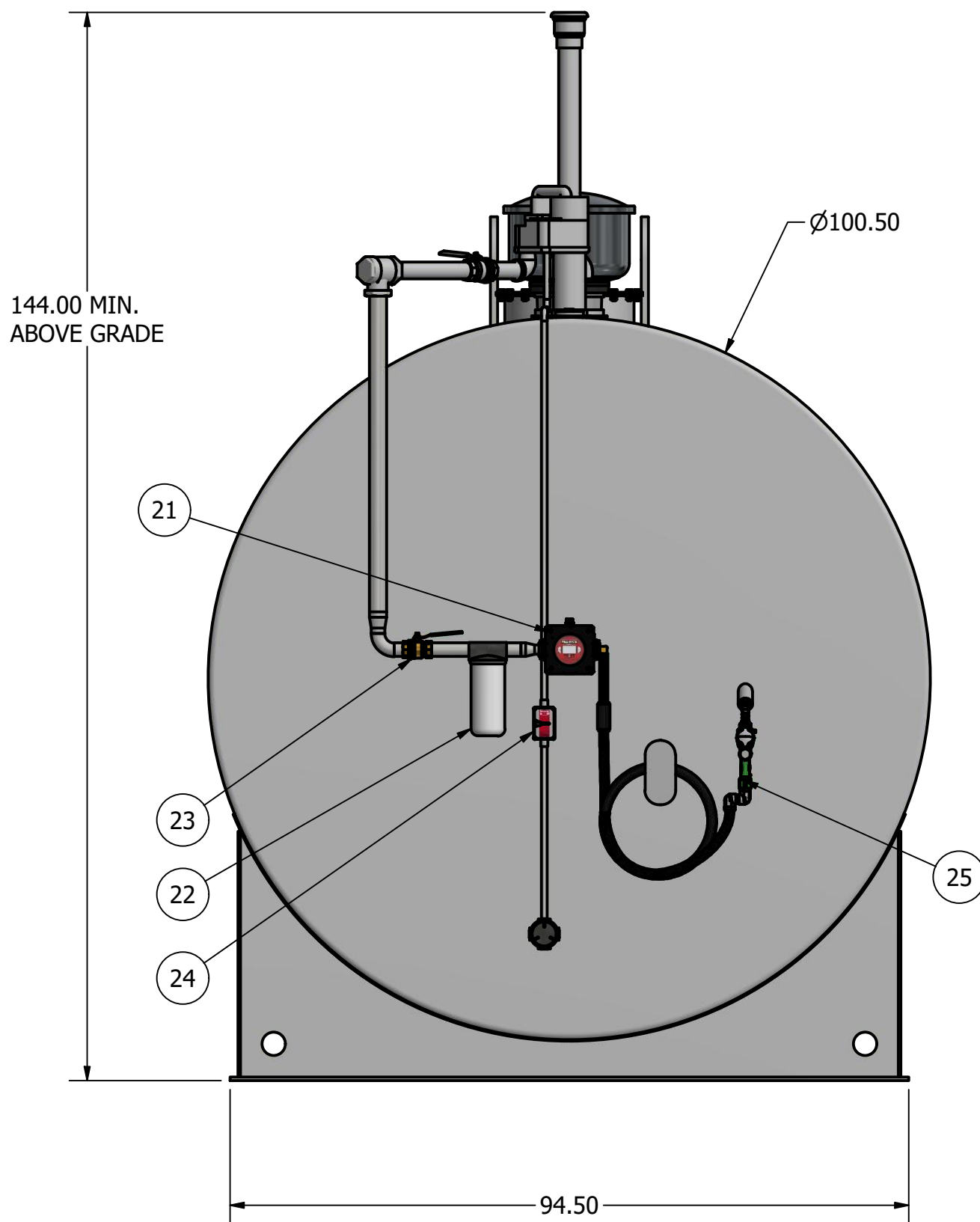
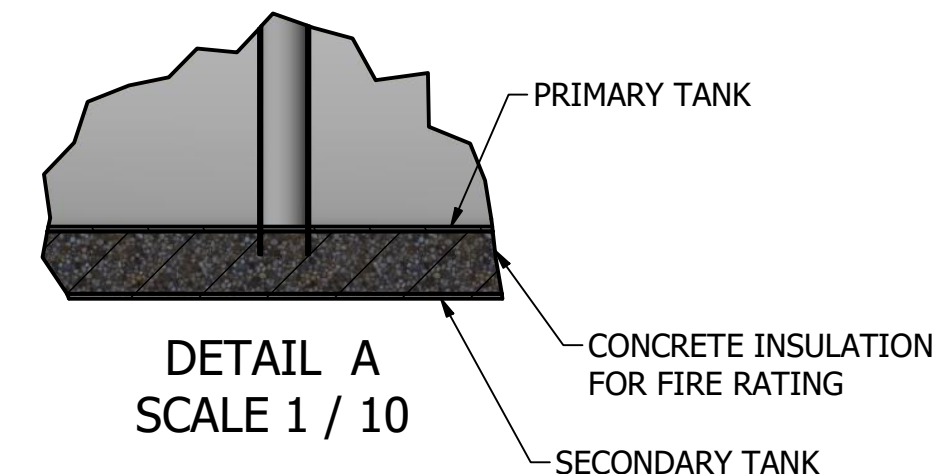

SHELL THICKNESS: 1/4"
HEAD THICKNESS: 1/4"

STI
SwRI
UL

LEAD TIMES BEGIN UPON RECEIPT OF SIGNED APPROVED DRAWING, WHICH MUST BE RETURNED BEFORE PRODUCTION CAN BEGIN #

This document and all information and design thereon are the property of EnviroSAFE Fuel Systems. This document is confidential and must not be made public or copied without written authorization from EnviroSAFE and is subject to return upon demand. No use of this document or any design thereon is permitted except as is specifically authorized in writing by EnviroSAFE. Acceptance of possession of this document constitutes full agreement with the above conditions. All Rights Reserved. Memco, Inc

DRAWN BY	AP	9/20/2019
MEMCO REP		
QUOTE #	6000 GALLON FG FARM FLEET	
Customer Approval Signature		

MEMCO, INC		
6,000 GALLON FIREGUARD FARM FLEET SYSTEM		
SIZE	DWG NO	REV
C	6000 GALLON FG FARM FLEET	
SCALE		SHEET 2 OF 4

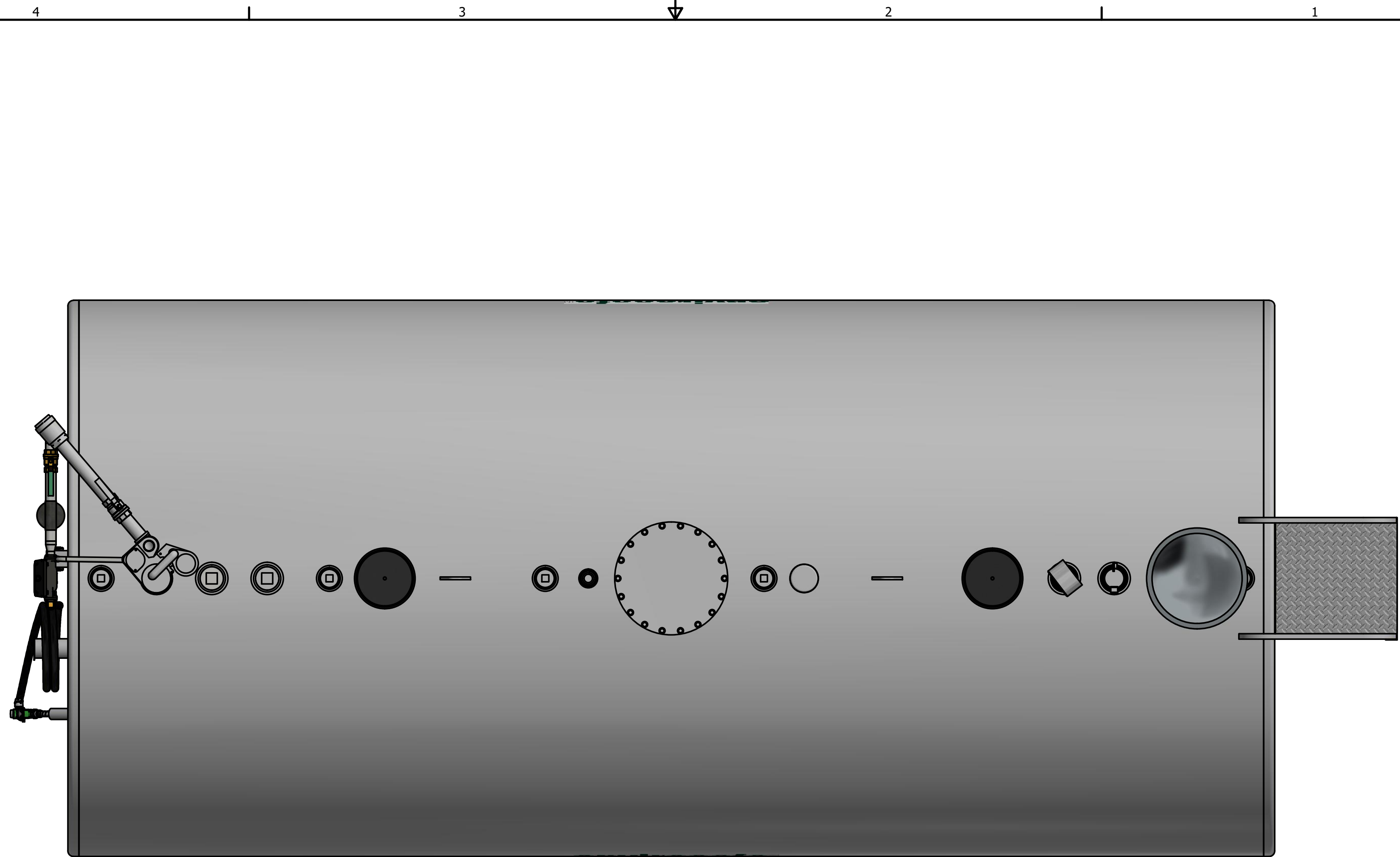

LEAD TIMES BEGIN UPON RECEIPT OF SIGNED APPROVED DRAWING, WHICH MUST BE RETURNED BEFORE PRODUCTION CAN BEGIN #

STI
SwRI
UL

This document and all information and design thereon are the property of Envirosafe Fuel Systems. This document is confidential and must not be made public or copied without written authorization from Envirosafe and is subject to return upon demand. No use of this document or any design thereon is permitted except as is specifically authorized in writing by Envirosafe. Acceptance of possession of this document constitutes full agreement with the above conditions. All Rights Reserved. Memco, Inc

DRAWN BY AP		9/20/2019		MEMCO, INC	
MEMCO REP				 6,000 GALLON FIREGUARD FARM FLEET SYSTEM <small>ABOVE-GROUND FUEL SYSTEMS</small>	
QUOTE # 6000 GALLON FG FARM FLEET					
Customer Approval Signature				SIZE C	DWG NO 6000 GALLON FG FARM FLEET
				SCALE	REV
				SHEET 3 OF 4	